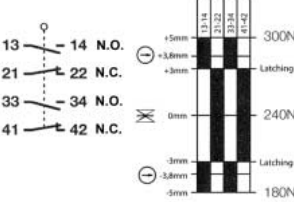
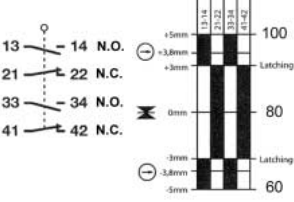
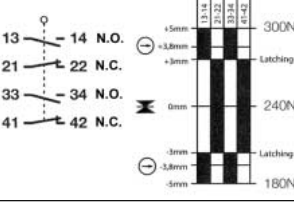
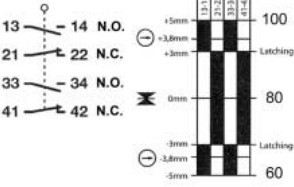

SAFETY ROPE PULL SWITCHES

SPECIFICATIONS	KEY FEATURES	4 POLE
<p>NEMA 4, 12, IP 67</p> <p>4 Pole</p> <p>10 Amp 250V AC</p> <p>-13° F, + 158° F min/max temp.</p> <p>Cable Entry Thread M20 x 1.5 + 1/2" NPT</p> <p>CE, BG, IEC 60 947-5-5, EN418</p> <p>UL, CSA</p> <p>BG Safety Agency Approved</p>	<ul style="list-style-type: none"> • Emergency Stop Button • Rope tension window gage • Quick clamp rope attach device • Cage clamp terminals • Fibre glass reinforced poly carbonate housing • Metal mtg. bracket + head • Positive Opening N.C. contact → 	<p>1.5"</p>  <p>12"</p> <p>Shown with Emergency-stop button option and Quick Clamp rope install device.</p>

SR-U2 Z-NA

Version	Contacts	Part #	List	Pre-tension Force ^①	Actuation Pull Force	Max Rope Length
Includes: 1. Emergency Stop Button 2. Reset Button 3. Quick clamp rope device		SR U2Z NA QF 300	\$340	66 lbs.	14 lbs.	240ft.
1. Emergency Stop Button 2. Reset Button 3. Quick clamp rope device		SR U2Z NA QF 100	\$340	22 lbs.	5 lbs.	80 ft.
Reset Button Only		SR-U2 Z 300	\$290	66 lbs.	14 lbs.	240ft.
Reset Button Only		SR-U2 Z 100	\$290	22 lbs.	5 lbs.	80 ft.

Technical Specifications

Slow action contacts
20 operations per minute

① 38 lbs. available per request.

INGENIOUS

Quick Clamp Rope Attach Device

SR-U2Z-NA SERIES

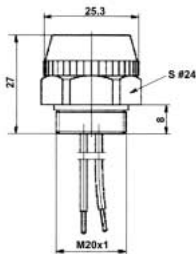
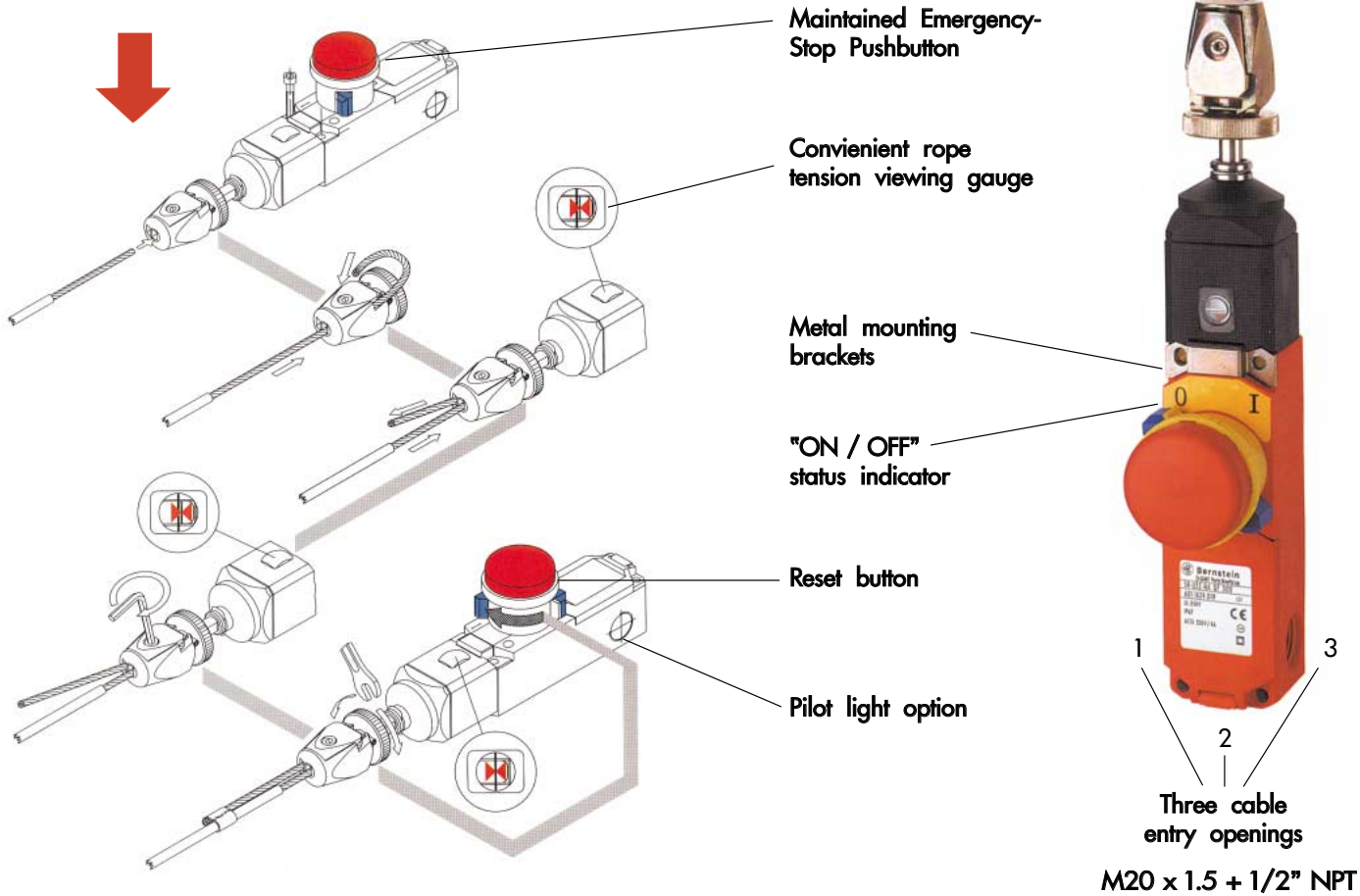

Red Pilot light (For ON or OFF)
(Attach in cable entry opening)

Volt	Part#	List
24-230V AC/DC	M-20 PILOT	\$56

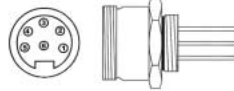

Quick Connect Option:
See page 25.
For Plug and Socket options.



Cord Grip Cable Gland Option:
Add "GR" to part # to replace the standard M20 to 1/2" NPT Adaptor.
For 5mm to 13mm cable diameter
Example: SRU-U2Z NAQ F300G
(no extra charge)

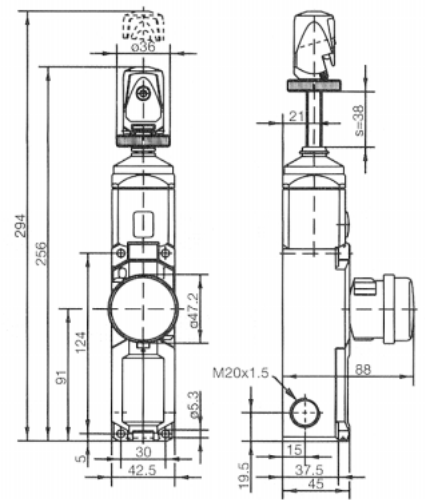

SRU-U2Z-NA-QF300

SR-U2 Z 300 (100)

Reset only version

ROPE PULL SWITCH ACCESSORIES

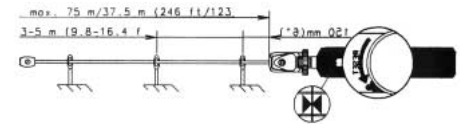
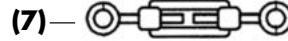
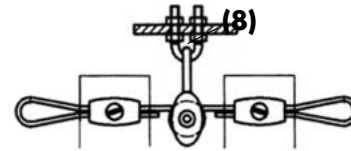
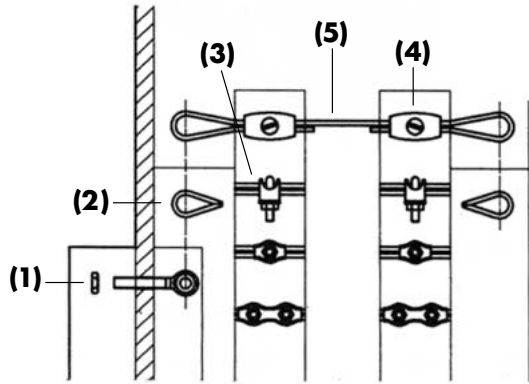

#SRU 2ZNA QF300
 Max length 240 ft.
 Rope supports every 9' → 16' feet.



(1) Nut Eye Bolt

List

(2) Thimble

List

(3) Rope Clamp

List

(4) Screw Clamp

List

M 6 x 50 Bolt
(6mm x 50mm)

\$8

R-Thimble

\$2.50

R-Clamp

\$3

R-Clamp

\$3

M 10 x 50 Bolt
(10mm x 50mm)



(6) Spring

List

(7) Turnbuckle

List

(8) Swivel Pully Block w/clamp

List

(5) Red Cable Metal Rope

List

For use on bi-directional switches

R-Spring
(5lbs.)

\$12

R-Turnbuckle

\$15

R-Pulley

\$20

#Cable ___ ft.
 ___ enter ft.

\$0.80

For use on Sil, SiRK rope pull switches

ex: Cable 100ft.

per ft.

Contacts	Max. Rope Cable Length	Amps/Volts AC UL + CSA	Dimensions	Operations Per Minute	Pre-Tension Force	Part# NEMA 4, 12	List	Housings
 	20 ft.	10A / 300V		17	14.7 lbs.	SiEM2-UV1ZRast reset button	\$210	 Aluminum
 	32 ft.	10A / 300V		50	43 lbs.	SiD-UV1Z no reset (spring return)	\$158	 Aluminum
 	162 ft.	10A / 300V		20	56 lbs.	SiN-UV1ZPRast reset button	\$570	 Aluminum
 	325 ft.	10A / 250V IEC - NO UL CSA		10	0 lbs.	SiI1UZ/U1ZAKR-R pull ring reset	\$560	 Iron
Two Rope Springs required (one on each side) for pre-tension								
 	325 ft.	10A / 250V		30	0 lbs.	SiRK-U2ZRMLD pull lever reset	contact factory	 Plastic Housing with Pilot Light
Two Rope Springs required (one on each side) for pre-tension								